

# FL05-Series



## KEY ADVANTAGES

- Cost-effective and efficient to maximise energy and maintenance savings
- Fully compatible with existing infrastructures (mounting and cabling) in retrofit projects
- Professional light distribution with symmetrical and asymmetrical light offers endless possibilities
- Modular design offers the advantage of product flexibility for high-power applications
- Optional reflector to reduce light pollution and optimize glare control
- The inclination of each module and/or the entire bracket can be adjusted on site to meet different needs
- 0-10V, DALI, instant lighting control optional.
- Extra 20kV SPD with LED to offer double protection from lightning

## TYPES OF APPLICATION

- LARGE AREAS
- SPORT FACILITIES



SPORT FACILITIES



LARGE AREAS



## GENERAL INFORMATION

Driver included	Yes
CE mark	Yes
SAA Mark	Yes
RoHS compliant	Yes
Safety features	Open circuit protection Short circuit protection Overvoltage protection
Testing standard	LM-79-19 (all measurements in ISO17025 accredited laboratory)

## HOUSING AND FINISH

Housing	Aluminium
Optic	Polycarbonate
Respirator	Yes
Housing finish	Electrostatic polyester powder coating
Standard colour(s)	RAL 9017 black
Tightness level	IP 66
Impact resistance	IK 09
Wind Force Test	Pass

## OPERATING CONDITIONS

Operating temperature range (Ta)	-30°C to + 50°C
Operating Humidity	10-90%RH
Mounting Option	Bracket Mounting
Warranty	5 years

## PERFORMANCE

Power	250W/500W/750W/ 1000W/1250W
Efficacy	170lm/W,150lm/W
Power Efficiency	≥90%
Start Time	≤0.2S

## ELECTRICAL INFORMATION

Electrical class	Class I EU
Nominal voltage	200-240V   50/60Hz
Power factor (at full load)	0.9
Surge protection options (kV)	20KV-Line-Line 20KV-Line-Earth
Electromagnetic compatibility (EMC)	EN 55015:2019/A11:2020, EN 61000 3-2:2019, EN 61000-3-3:2013, EN 61547:2009, EN 62493:2015
Total Harmonic Distortion(THD)	IEC 61000-3-2 Class C <20%
Driver Type	Constant current(CC)
Flicker	No
For fixed Class 1 luminaires, overvoltage protective devices which comply with IEC 61643-11 shall be disconnected from the circuit.	
withstand voltage	1.5KV 60S 10mA

※Lamp switch must control L line or control L and N lines.

## OPTICAL INFORMATION

LED Type	SMD3030/5050
Beam Angle	15° / 30° / 45° / 60° / 90° 110X25° / 110X40°
Recommended installation height	15m to 45m
Color Tolerance	Ra70 ≤7 Ra80 ≤5
LED colour temperature	3000K / 4000K / 5000K / 5700K / 6500K
Colour rendering index (CRI)	CRI>70 standard CRI>80 optional
Upward Light Output Ratio (ULOR)	0%

※Ra measurement tolerance is ±2.

## LIFETIME OF THE LEDS @ TA 25°C

All configurations	
L70B10	>100,000h
L80B10	>50,000h
L90B10	>30,000h
Switching Cycles	>100,000 times

## STANDARD VERSION

POWER	LUMENS	EFFICACY
250W	42,500LM	170LM/W(Ra70)
	40,000LM	160LM/W(Ra80)
500W	85,000LM	170LM/W(Ra70)
	80,000LM	160LM/W(Ra80)
750W	127,500LM	170LM/W(Ra70)
	120,000LM	160LM/W(Ra80)
1000W	170,000LM	170LM/W(Ra70)
	160,000LM	160LM/W(Ra80)
1250W	212,500LM	170LM/W(Ra70)
	200,000LM	160LM/W(Ra80)

## ECO VERSION

POWER	LUMENS	EFFICACY
250W	37,500LM	150LM/W(Ra70)
	35,000LM	140LM/W(Ra80)
500W	75,000LM	150LM/W(Ra70)
	70,000LM	140LM/W(Ra80)
750W	112,500LM	150LM/W(Ra70)
	105,000LM	140LM/W(Ra80)
1000W	150,000LM	150LM/W(Ra70)
	140,000LM	140LM/W(Ra80)
1250W	187,500LM	150LM/W(Ra70)
	175,000LM	140LM/W(Ra80)

※ The Performance Data is tested base on 230VAC, 30° and 4000K for all versions  
 ※ Power Consumption Tolerance ±5% (Apply to all versions)  
 ※ Lumen Efficiency Tolerance ±5% (Apply to all versions)

## PACKAGING

POWER	PACKAGE SIZE	QTY/CTN	SINGLE PIECE VOLUME	NET WEIGHT	GROSS WEIGHT	20GP	40HQ
250W	L500*W300*H185mm	1PCS/CTN	0.0278m <sup>3</sup>	5kg	5.4kg	1699pcs	4145pcs
500W	L620*W545*H225mm	1PCS/CTN	0.076m <sup>3</sup>	13.4kg	15.2kg	399pcs	967pcs
750W	L825*W545*H225mm	1PCS/CTN	0.1012m <sup>3</sup>	18.1kg	20.3kg	275pcs	670pcs
1000W	L1035*W545*H225mm	1PCS/CTN	0.1269m <sup>3</sup>	21.3kg	24.5kg	209pcs	522pcs
1250W	L1240*W545*H225mm	1PCS/CTN	0.1521m <sup>3</sup>	27.4kg	30.9kg	180pcs	454pcs

**1007**<sub>PCS</sub>  
250W/20GP

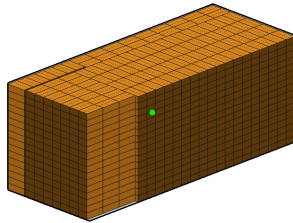

**2446**<sub>PCS</sub>  
250W/40HQ

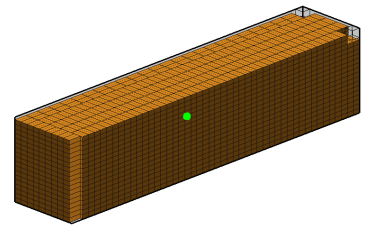

**399**<sub>PCS</sub>  
500W/20GP

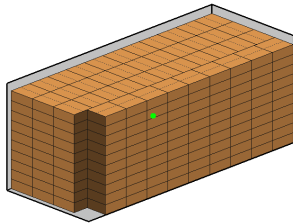

**967**<sub>PCS</sub>  
500W/40HQ

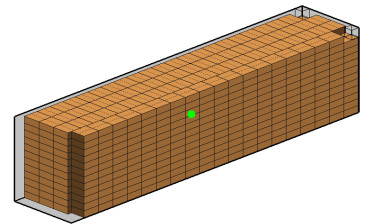

**275**<sub>PCS</sub>  
750W/20GP

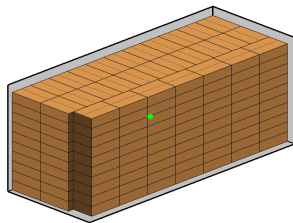

**670**<sub>PCS</sub>  
750W/40HQ

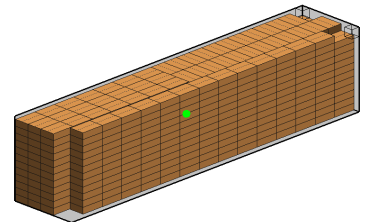

**209**<sub>PCS</sub>  
1000W/20GP

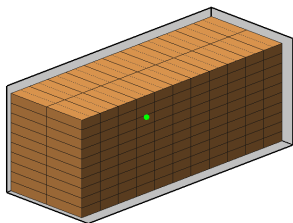

**522**<sub>PCS</sub>  
1000W/40HQ

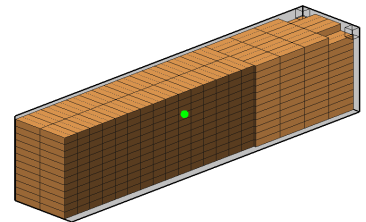

**180**<sub>PCS</sub>  
1250W/20GP

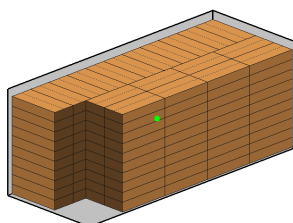

**454**<sub>PCS</sub>  
1250W/40HQ

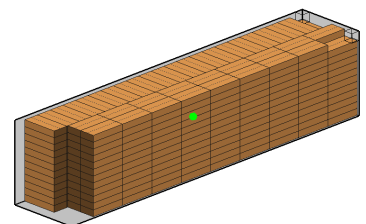

## LIGHT DISTRIBUTIONS

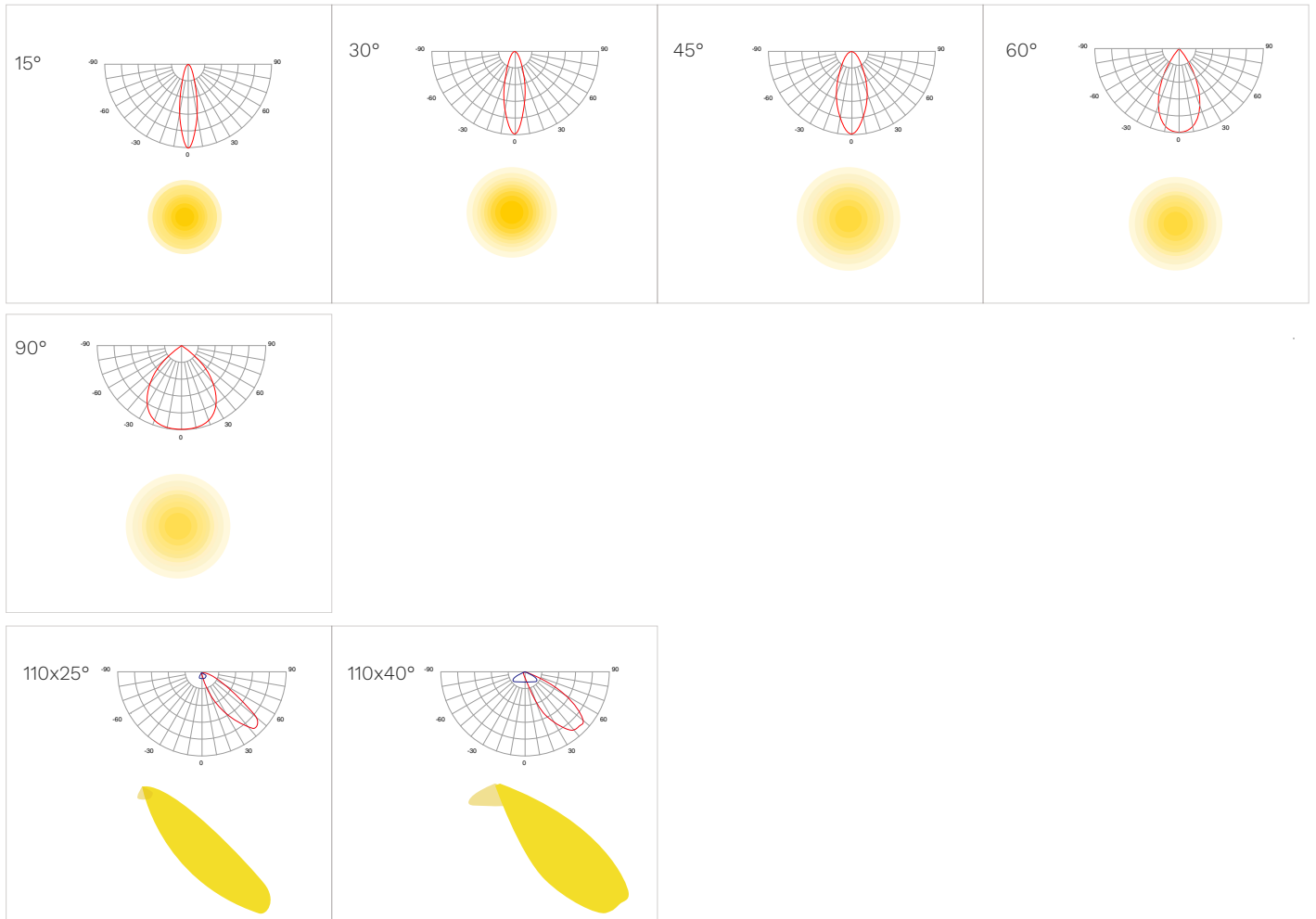

※ 110x25° / 110x40° is a special light distribution for 5050 LED chip

## OPTIONAL ACCESSORIES

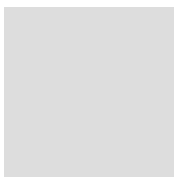

250W

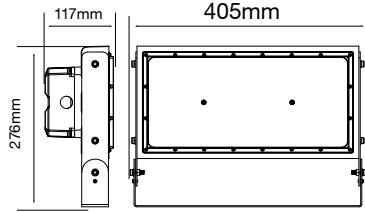

500W

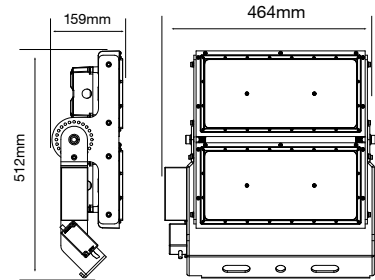

750W

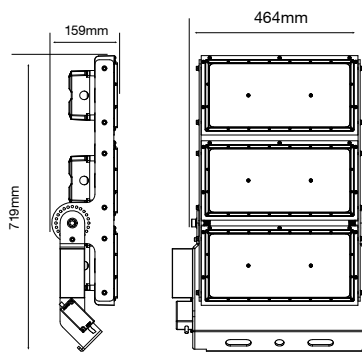

1000W

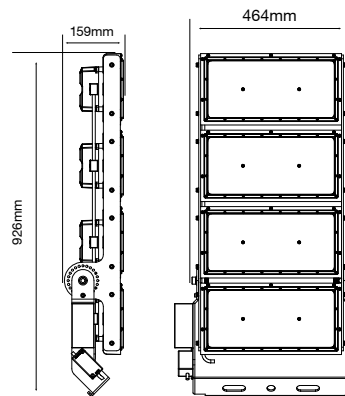

1250W

